

Beam Switch OS-12C / OS-12C (HT0.1) Single / Double Beams

MANUFACTURER'S STATEMENT

When using this apparatus, please read this manual thoroughly to operate correctly. In this manual, a variety of illustrations and expressions are shown to prevent you and other people from undergoing any injury or damage of property during the use of the apparatus. The meanings of the expressions are as follows: Please learn the following first and then read the contents of this manual.

Warning	Indicates that the disregard of the warning may result in serious injury or death.
Caution	Indicates that the disregard of the caution may result in injury or physical damages.

- Note**
- When the equipment is in failure, the door is held open. (This is the function to secure the safety of traffic.)
 - Only use the sensor as specified in the supplied instructions.
 - Be sure to install the sensor in accordance with the local laws and standards of your country.
 - Before leaving the jobsite, be sure that this sensor is operating properly and instruct the building owner/operator on proper operation of this sensor.

Warning Danger of electric shock.
Be sure to turn off the power supply when carrying out electrical works. Do not wash, disassemble, rebuild or repair the sensor by yourself.

Warning Danger of getting caught between the door.
(Please explain to the building owner/operator)
Even when someone stops on the threshold, the door closes unless the light beam is cut off (The beam switch outputs the signal only when the light beam is cut off). The beam switch is not designed as an apparatus to prevent accidents. It should be used strictly for the purpose of an auxiliary apparatus for safety.

SPECIFICATIONS

Model	OS-12C / OS-12C (HT0.1)	
Installation Distance	Less than 10m (32' 10")	
Detection Method	Point to Point Near Infrared Light Beam	
Power Supply	12 to 24V AC / 12 to 30V DC	
Current Draw	160mA MAX	
Operation Indicator	Stand-by	BEAM1 / BEAM2 : GREEN ON / RED ON
	Detection Active	: GREEN OFF / RED OFF
	Insufficient sensitivity	: GREEN BLINK / RED BLINK
Output Contact	N.O. / N.C. 50V 0.3A (Resistance Load)	
Response Time	Approx. 0.1 sec (from the moment of beam cut-off)	
Relay Hold Time	Approx. 0.5 sec / OS-12C, 0.1 sec / OS-12C (HT0.1) (from the moment of beam input)	
Operating Temperature	-20°C to +55°C (-4°F to +131°F)	
Weight	Amplifier: 65g (2.3oz)	
Component	1 Amplifier, 2 Mounting screws, 1 Manual (Optional sensor head is necessary for operation)	

- Note 1) It is possible to use OS-12C as an amplifier for 1 or 2 beam use by attaching a separately sold SensorHead.
- Note 2) The specifications herein are subject to change without prior notice due to improvements.

OUTER DIMENSIONS

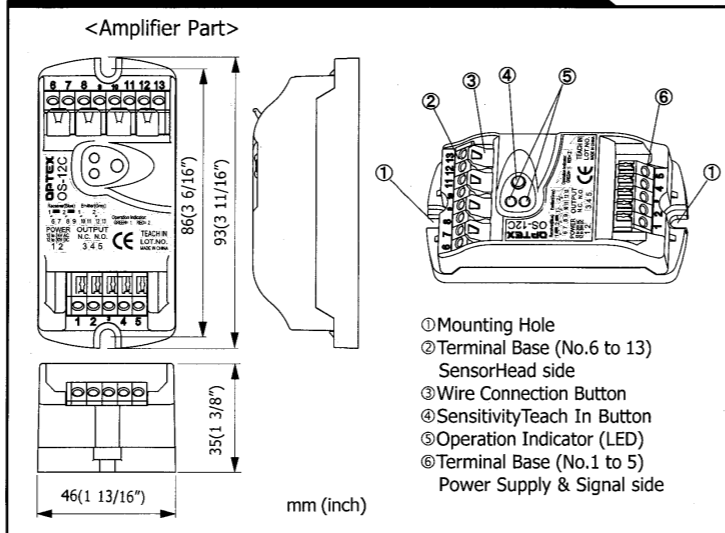

SEPARATELY SOLD OPTIONAL ITEMS

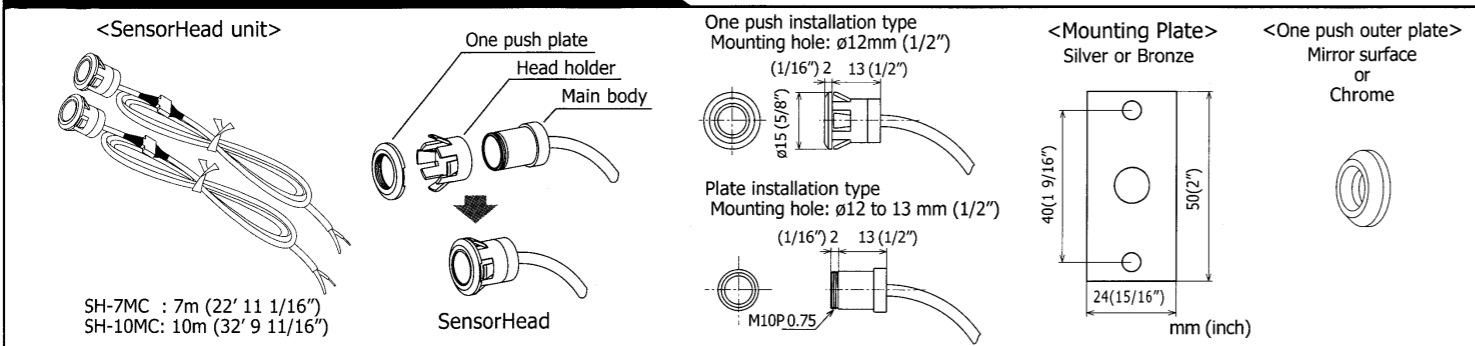

INSTALLATION

1 Mounting the SensorHeads (Option)

① One push installation type

Drill a mounting hole ø12mm (1/2") on the door jamb. Put the sensor heads into the mounting hole.

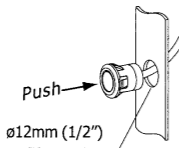

◆ On drilling the mounting holes ◆

- Be sure to drill holes so that the SensorHeads faces each other.
- After drilling the holes, remove the flashes around the holes. Otherwise, the apparatus may not operate properly as the SensorHead rides on the flashes causing tilts.

◆ Installation Site Environment ◆

Do not place any swaying object which cuts off the beam path. Otherwise the door may be held open.

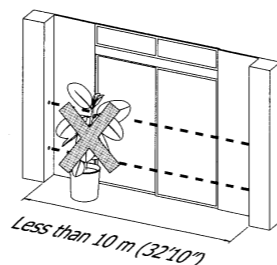

② Plate installation type

Drill a mounting hole ø12 to 13 mm (1/2") and two screw hole ø3.5 mm (1/8") on the door jamb.

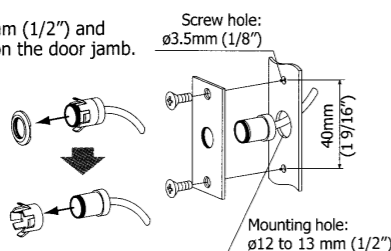

Remove one push plate and head holder from sensor head. Affix the main body to the plate. Screw the plate to the door jamb.

◆ On setting of one push plate ◆

Be sure to push the SensorHeads in securely. If the SensorHeads are not secured, it may cause an unnecessary activation signal.

◆ Distance between the SensorHeads ◆

Be sure to set the distance to less than 10m (32' 10"). If the distance is more than 10m (32' 10"), the door may be held open.

2 Installing the amplifier

Use the provided screws (2 pieces).
*The size of the hole is ø3.5 mm (1/8")

INSTALLATION (CONTINUED)

3 Wiring SensorHeads

- ◆ Cutting the wires ◆
When cutting the wires, prepare the tip of the wires as follows:

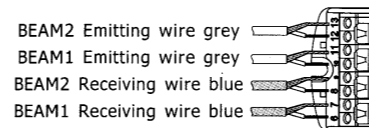
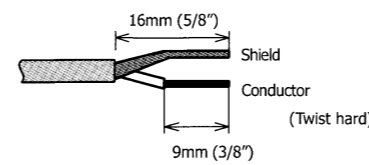

- ◆ Prohibition of extending wires ◆
Do not extend the wires. Otherwise, the apparatus may be influenced by noises causing malfunction.

Warning Danger of electric shock.
Before starting the procedure, be sure to turn off the power supply.

Caution Risk of breaking the apparatus.
When cutting the wires, be sure to prepare the tip of the wires as shown on the left: If the covers of the shielding wires are peeled off too long, the adjacent tips can easily contact each other causing breakdown of the apparatus.

Insert the wires to Terminal Block 6-13 as shown on the left.

Insert the wire as you press the Wire Connection Button. Then, release the finger. Be sure to insert both the shield and the conductor.

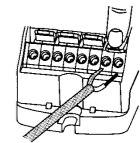

4 Connecting power supply wires and output signal wires

Insert the wires to Terminal Block 1-5 as shown below.

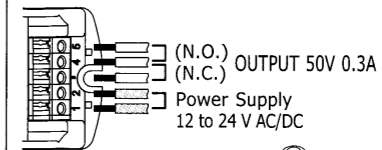

Press the Wire Connection Button of the power supply signal side and insert the wires. Be sure that all the wires are securely connected.

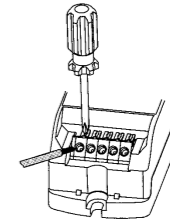

Caution Risk of breaking down the apparatus.
Be sure to connect the power supply wires to terminal 1 and 2. If wired wrongly, the apparatus may break down.

◆ Stated connection capacity ◆
• Solid (Rigid) ø0.4-ø1.2mm (AWG26-18)
• Stranded (Flexible) 0.3mm²-0.75mm² (AWG22-20)
(Strand diameter shall be more than 0.18mm)

◆ Warning about wiring ◆
Do not connect more than 2 wires to one terminal.

ADJUSTMENT & CHECKING

1 Sensitivity Adjustment

- Press Sensitivity Teach In Button for more than one second. When the green and red LED blinking becomes green and red (no blinking), the setting is completed. The proper sensitivity is adjusted automatically.
- Check the auto-set adjustment with the table below.



LED	State
Green/Red ON	The sensitivity has been set correctly. The adjustment is completed. (When using two beam)
Green ON	The sensitivity has been set correctly. The adjustment is completed. (When using one beam)
Green/Red Blink alternately	The sensitivity is insufficient. Check the followings.

Checking Item

If there is no person or object in the detection area. If the lens surface is clean. If the wire connections are done properly. If the emitting/receiving SensorHeads are mounted straight. (They should not be tilted.)

◆ Sensitivity Adjustment ◆

Set the sensitivity in the environment same as the actual regular use. Also, be sure that there is no swaying object in the area.

◆ When changing the number of Sensor Head ◆

Be sure to press the Teach In Button. All SensorHeads can be adjusted at once. The apparatus does not operate properly if Teach In Button is not pressed.

◆ Re-setup of sensitivity ◆

For the maintenance, press Sensitivity Teach In Button to readjust. The sensitivity is set automatically.

2 Checking the operation

Check the operation of the apparatus according to the following chart.

Entry motion (Image)	Operation Indicator			
	OFF	ON (Green/Red)	OFF	ON (Green/Red)
Status	Power OFF *Failure of the apparatus	Stand-by status No person or object exists between the SensorHeads	While a person or object is passing in the beam path	After the traffic has passed, the status becomes stand-by.
Output	N.O. CLOSE N.C. OPEN	OPEN CLOSE	CLOSE OPEN	OPEN CLOSE

Inform the following items to the building owner/operator

- When turning the power on, always walk-test the sensor to ensure proper operation.
- Always keep the Lens surface clean. If dirty, wipe the lens with a damp cloth (Do not use any cleaner or solvent).
- Do not wash the sensor with water.
- Do not disassemble, rebuild or repair the sensor yourself; otherwise electric shock may occur.
- Contact your installer or the sales engineer if you want to change the settings.
- Do not place an object that moves or emits light in the detection area. (Ex. Plant, illumination etc.)
- Do not paint the Lens surface.

TROUBLESHOOTING

Trouble	Possible Cause	Solution
Does not operate	Irregular supply voltage	Adjust to the stated voltage.
	Wire cut or bad connection	Check the wiring.
	Inappropriate installation distance or condition	Check the installation distance and condition.
Operates by itself (Ghosting)	Inappropriate installation distance or condition	Check the installation distance and condition.
	Something swaying between the SensorHeads cutting off the beam.	Remove the obstruction.
	Dirty lens.	Remove the dirt.

Contact your installer or the sales engineer if:
- you need to change the settings or replace the sensor.
- the trouble still persists after checking and remedying as described above.

FCC STATEMENT

This device complies with Part 15 of the FCC Rules. Operation is subject to the following two conditions: (1) This device may not cause harmful interference, and (2) this device must accept any interference received, including interference that may cause undesired operation.

Warning:
This equipment has been tested and found to comply with the limits for a Class B device, pursuant to Part 15 of the FCC Rules. These limits are designed to provide reasonable protection against harmful interference in a residential installation. This equipment generates, uses and can radiate radio frequency energy and, if not installed and used in accordance with the instructions, may cause harmful interference to radio communications. However, there is no guarantee that interference will not occur in a particular installation. If this equipment does cause harmful interference to radio or television reception, which can be determined by turning the equipment off and on, the user is encouraged to try to correct the interference by one or more of the following measures:
- Reorient or relocate the receiving antenna.
- Increase the separation between the equipment and receiver.
- Connect the equipment into an outlet on a circuit different from that to which the receiver is connected.
- Consult the dealer or an experienced radio / TV technician for help.